

L-Cube

LC 6938

Monteringsanvisning

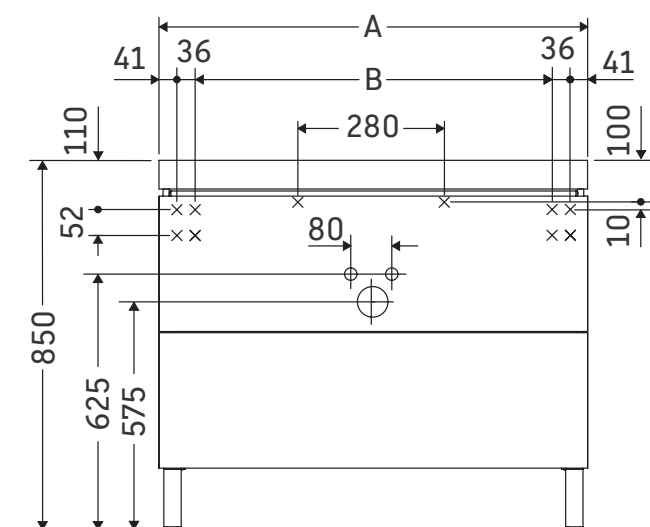

A mm	B mm
1000	846

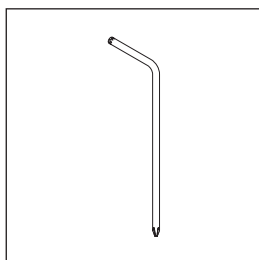
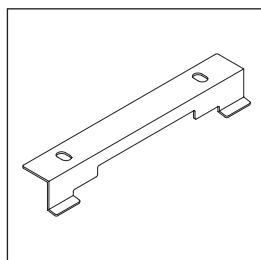
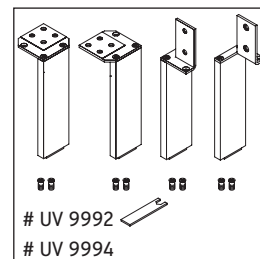
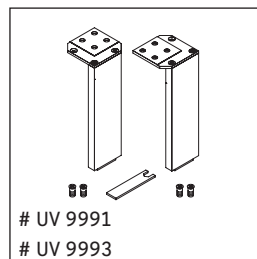
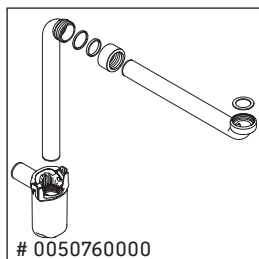
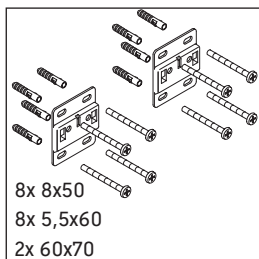
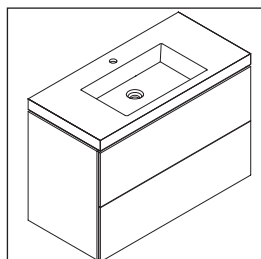

Bruksinformasjon

Bademøbelserien tilsvarer de gyldige standardene og retningslinjene på tidspunktet for utleveringen og er utformet til bruk på badetrom. En direkte vannsprut f.eks. ved dusjing må unngås.

Vi forebeholder oss retten til tekniske forbedringer og optiske endringer på de avbildede produktene.

